

BOESCH

BN SERIES

2.5" & 3" Full Free
Passage Submersible
Sewage Pump



**OPERATION
AND
MAINTENANCE
MANUAL**

CE

Instruction Manual

2.5" & 3" Full Free Passage Submersible Sewage Pump

BN SERIES

INDEX

Introduction.....	PAGE 3	Construction (BN SERIES 1.5~2HP).....	PAGE 6
Specifications.....	PAGE 3	Construction (BN SERIES 3HP).....	PAGE 8
Installation.....	PAGE 4	Construction (BN SERIES 4~5.5HP).....	PAGE 10
Electrical wiring.....	PAGE 4	Disassembly and Assembly.....	PAGE 12
Operation.....	PAGE 5	Nameplate format.....	PAGE 13
Maintenance.....	PAGE 5	Troubleshooting.....	PAGE 14

Introduction

Check the following upon delivery:

1. Is the pump exactly what you ordered? Check nameplate. It is especially important that you check whether the pump is to be used with 50 or 60 Hz.
2. Has any damage occurred during shipment? Are any bolts or nuts loose?
3. Have all necessary accessories been supplied?
(For a list of standard accessories see Construction section.)

**We recommend that you keep a spare pump on hand in case of emergencies.
Keep this instruction manual in a safe place for future reference.**

Specifications

Check the nameplate for your pump's head (Hmax), discharge volume (Qmax), speed (R.P.M.), motor voltage and current.

Other specifications are noted in the chart below.

Item		Specifications		
Liquid handled	Type	Sewage, wastewater, miscellaneous drain water		
	Temperature	Non-Automation	1.5~5.5 HP	32~104°F(0~40°C)
		Automation	1.5~2 HP	32~104°F(0~40°C)
Materials	Pump Casing	EN-GJL-200		
	Impeller	EN-GJL-200		
	Shaft	AISI 410 stainless steel		
Motor type		Dry type submersible motor		
Shaft seal lubrication oil		Turbine No.32 ISO VG-32		
Maximum water depth		33 ft (10 m)		

Installation

Check the following before beginning installation:

Insulation resistance measurement

Place the pump on a dry surface. For this test neither the motor nor the cable should be immersed in water. Use a megger to measure the insulation resistance between ground and each phase of the motor. Do the same with any two phases until all pairs are completed. The megger should indicate an insulation resistance of no less than 20 mega ohms. While taking the measurement, keep the power supply cable off the ground.

Installation

1. **WARNING:** Under no circumstances should cable be pulled while the pump is being moved or installed.

Attach a chain or rope to the grip and install the pump.

2. This pump must not be installed on its side or dry operated. Ensure that it is installed upright on a secure base.

3. Install the pump in the tank where there is the least turbulence.

4. Install piping so that air will not be entrapped. If piping must be installed in such a way that air pockets are unavoidable, install an air release valve wherever such air pockets are most likely to develop.

5. Do not permit end of discharge piping to be submerged, as backflow will result when the pump is shut down.

6. **WARNING:** Do not operate the pump for more than 2 minutes with the water level near the lowest water level(H1) as shown on **Fig.1**.

7. Use **Fig. 2** for set up of floats to maintain safe operating water levels.

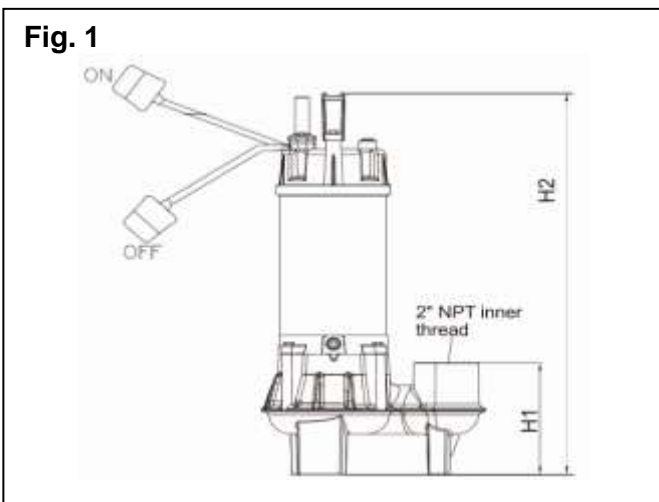

H1: Lowest water level (Motor flange)

H2: Operating water level

This must be above the top of the motor.

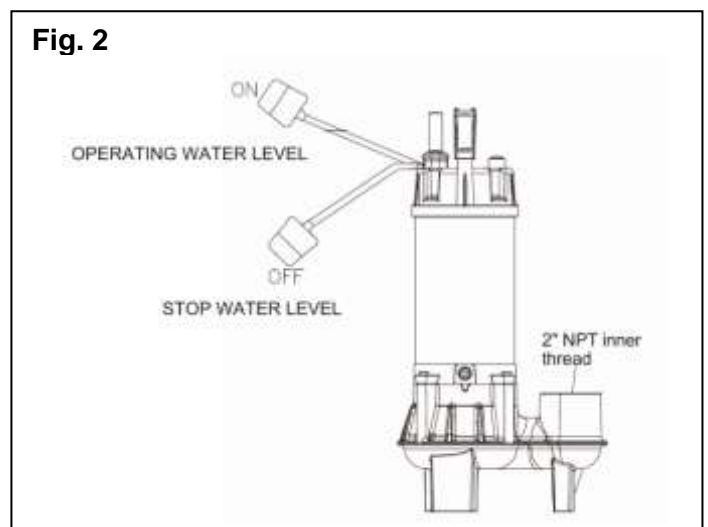

Electrical wiring

Wiring

- A) Wire as indicated for the appropriate start system as shown in **Fig-3 & 4** for single phase version and **Fig-5** for three phases.
- B) Loose connections will stop the pump. Make sure all electrical connections are secure.
- C) For three phase motors - Operate the pump for a short time (1 or 2 seconds) to verify the rotation of direction of the impeller, switch two of the three power cords to correct the rotation if necessary.
- D) Make sure to check the pump's direction of rotation with the pump exposed to the atmosphere. Operating the pump with reversed rotation while in submerged conditions under water will most likely damage the pump, which will lead to leakage and electrical shock.

Cable

WARNING: Never let the end of the cable contact water.

- A) Do not immerse any splicing in water.
- B) Do not pull power cable. Use the pump handle.
- C) Do not expose any cables to sunlight.

Grounding

Yellow/green cable should be connected to ground. Under no circumstances should the green (yellow/green) wire be connected to the power supply.

WARNING: Use short circuit breakers to prevent danger of electrical shock.

WARNING: Never start the pump while it is suspended, as the pump may jerk and cause serious accident involving injury.

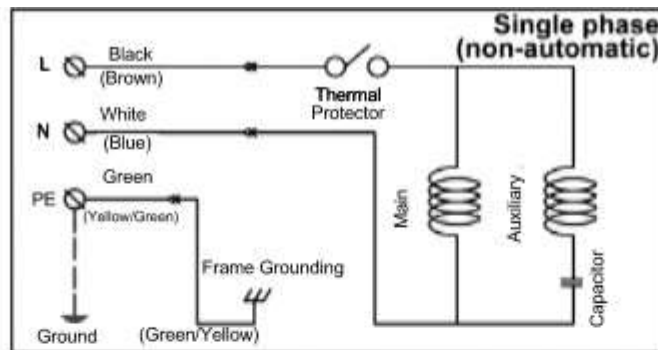

Fig-3

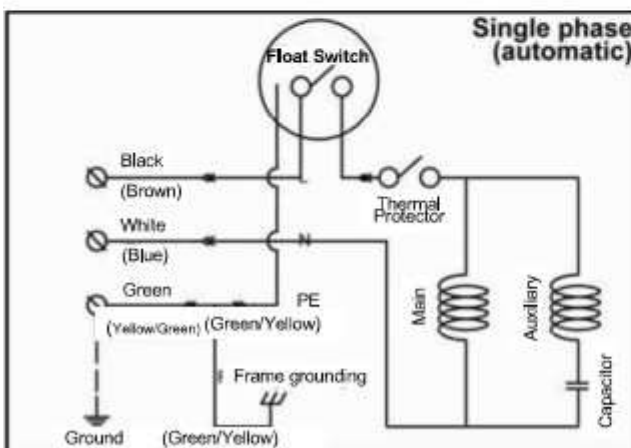

Fig-4

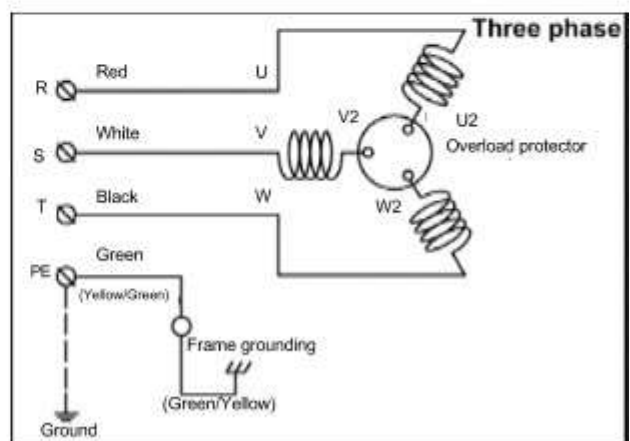

Fig-5

Operation

1. Before starting the pump

- a) After installation, measure the insulation resistance again.
- b) Check water level.

If the pump is operated continuously for an extended period of time in a dry condition or at the lowest water level, the motor protector will be activated. Constant repetition of this action will shorten pump service life.

2. Test operation

Non-automatic pump (BN)

Automatic pump (BN-Automatic)

- a) Turn the operating switch on and off a couple of times to check for normal pump start. Float switch must be raised for the pump to start.
- b) Next, check direction of rotation. If discharge volume is low, reverse two of the wires.

Maintenance

Check pressure, flow, voltage and current.

Refer to Troubleshooting section for recommendations.

1. Daily inspections

Check current fluctuation daily. If current fluctuation is great, even though within the limits, foreign matter may be clogging the pump. If the quantity of liquid discharged falls suddenly, foreign matter may be blocking the suction inlet.

2. Regular inspections

Monthly inspections

Measure insulation resistance as previously described.

Annual inspections

To prolong the service life of the mechanical seal, replace the oil in the mechanical seal chamber once a year. Cloudy oil is an indication of a defective mechanical seal requiring replacement. When replacing the oil, lay the pump on its side with filler plug on top. Fill suitable amount turbine oil No.32 (ISO VG-32)

Replacement of Parts

Replace the appropriate part when the following conditions appear:

Replacement part	Mechanical seal	Oil filler plug O-ring	Lubricating oil
Condition	Oil in mechanical seal chamber	Inspect or replace the oil	Oil is cloudy or dirty
Frequency	Annual	6 months	6 months







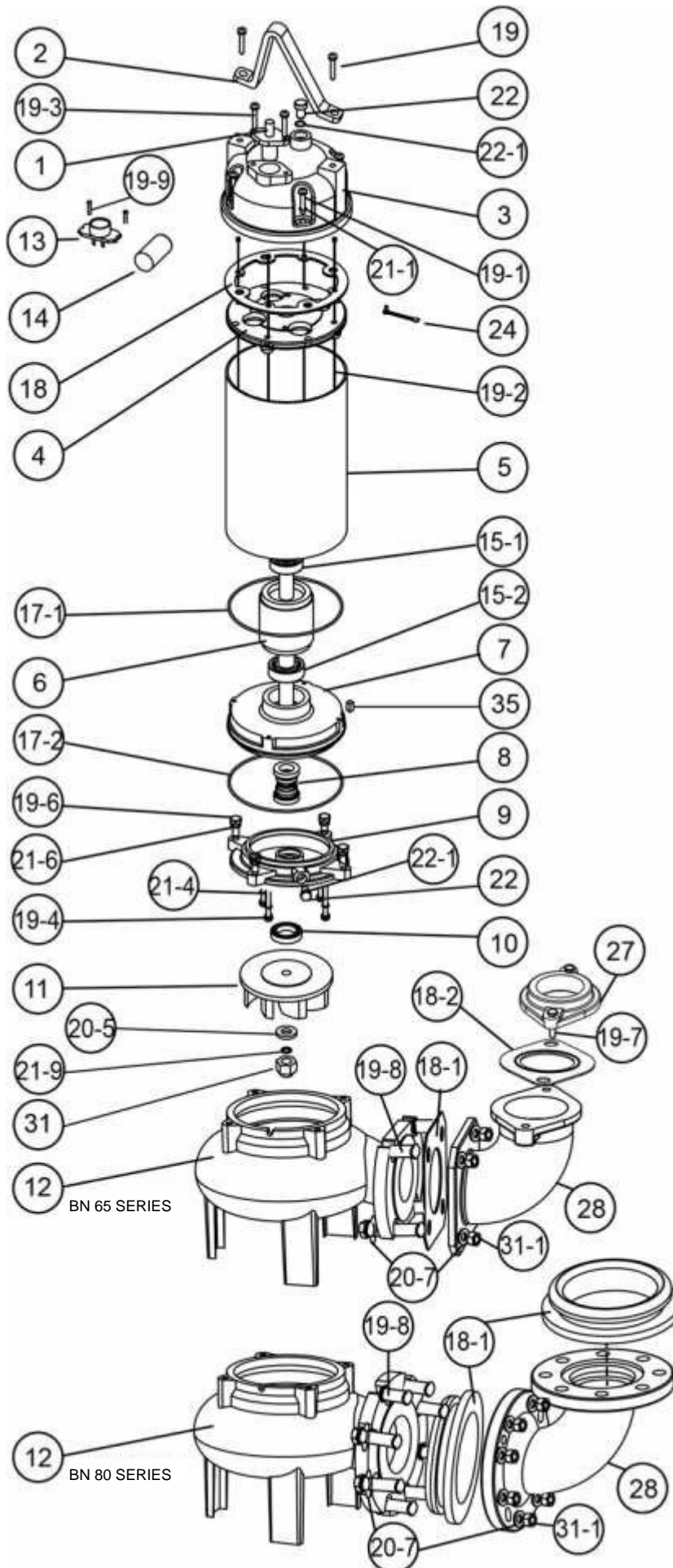











Note: above replacement schedule is based on normal operating conditions.

Motor output	1.5HP	2HP	3HP	4HP	5.5HP
Mechanical seal	15Ø			20Ø	
Lip seal	15Øx 24Øx 7 t			20Øx 38Øx 7 t	
Oil filler plug O-ring	(Inner diameter) x (outer diameter) x (thickness) = 7.52Øx14.5Øx3.53 t				
Lubricating oil (turbine oil #32)	280 cc			500 cc	

Construction



BN SERIES 1.5~2HP







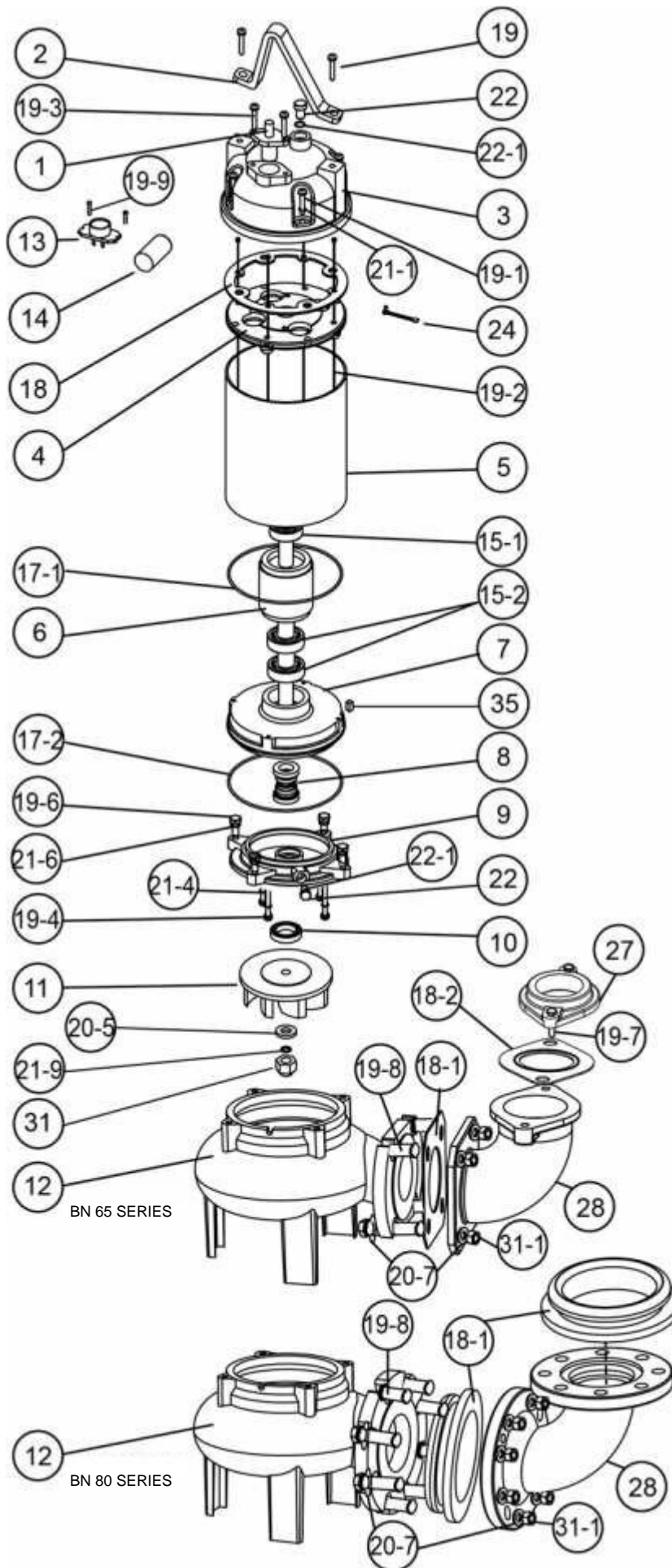













NO	Part	Material	Photo	NO	Part	Material	Photo
2	Handle	ASTM A36		12	Pump Casing (BN65)	EN-GJL-200	
3	Motor Cover	EN-GJL-200		12	Pump Casing (BN80)	EN-GJL-200	
4	Bracket	EN-GJL-200		15-1 15-2	Upper Bearing Lower Bearing	NTN/TPI	
5	Motor Housing +Stator	AISI 304		17-1 17-2	O-rings	NBR	
6	Shaft with Rotor	AISI 410		18	Gasket	NBR	
7	Oil Chamber	EN-GJL-200		18-1	Elbow Gasket (BN65)	NBR	
8	Mechanical Seal	CA/CE + SIC/SIC		18-1	Elbow Gasket (BN80)	NBR	
9	Seal Housing	EN-GJL-200		18-2	Flange Packing	NBR	
10	Lip Seal	NBR		27	Flange (BN65)	EN-GJL-200	
11	Impeller	EN-GJL-200		28	Elbow	EN-GJL-200	

NO	Part	Material	NO	Part	Material
1	Cable	H07RN-F/ SJTOW/STOW	20-5	Washer	AISI 304
13	Protector (3 Phase)	KLIXON	20-7	Washer	AISI 304
14	Capacitor (1 Phase)	-	21-1	Spring Washer	AISI 304
19	Screw	AISI 304	21-4	Washer with O-ring	AISI 304+NBR
19-1	Screw	AISI 304	21-6	Spring Washer	AISI 304
19-2	Long Screw of motor	Steel	21-9	Spring Washer	AISI 304
19-3	Screw	AISI 304	22	Oil Filler Plug	AISI 304
19-4	Screw	AISI 304	22-1	O-ring of Oil Filler Plug	NBR
19-6	Screw	AISI 304	24	Wire and Screw	AISI 304
19-7	Screw	AISI 304	31	Nut of impeller	AISI 304
19-8	Screw	AISI 304	31-1	Nut of Elbow	AISI 304
19-9	Screw	AISI 304	35	Key	AISI 304

Construction



BN SERIES 3HP







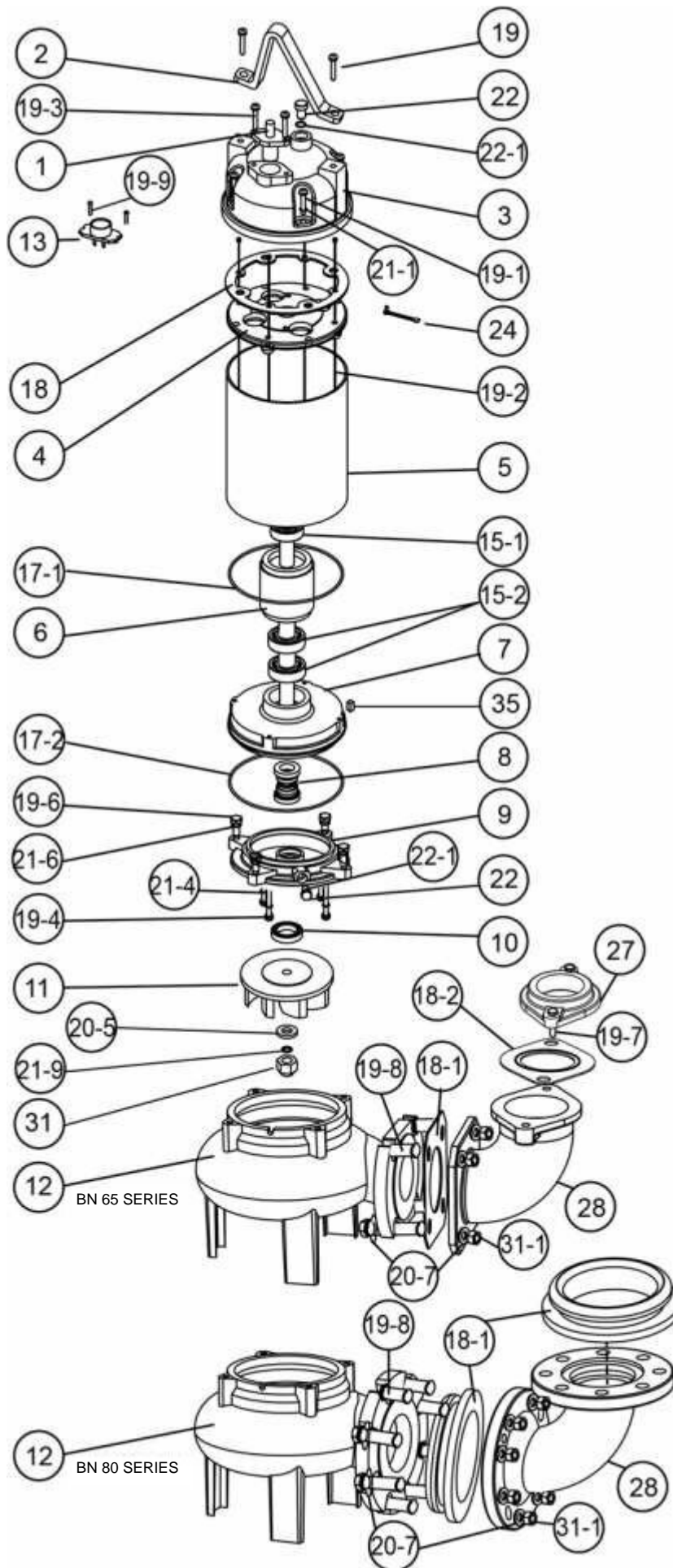













NO	Part	Material	Photo	NO	Part	Material	Photo
2	Handle	ASTM A36		12	Pump Casing (BN65)	EN-GJL-200	
3	Motor Cover	EN-GJL-200		12	Pump Casing (BN80)	EN-GJL-200	
4	Bracket	EN-GJL-200		15-1 15-2	Upper Bearing Lower Bearing	NTN/TPI	
5	Motor Housing +Stator	AISI 304		17-1 17-2	O-rings	NBR	
6	Shaft with Rotor	AISI 410		18	Gasket	NBR	
7	Oil Chamber	EN-GJL-200		18-1	Elbow Gasket (BN65)	NBR	
8	Mechanical Seal	CA/CE + SIC/SIC		18-1	Elbow Gasket (BN80)	NBR	
9	Seal Housing	EN-GJL-200		18-2	Flange Packing	NBR	
10	Lip Seal	NBR		27	Flange (BN65)	EN-GJL-200	
11	Impeller	EN-GJL-200		28	Elbow	EN-GJL-200	

NO	Part	Material	NO	Part	Material
1	Cable	H07RN-F/ SJTOW/STOW	20-5	Washer	AISI 304
13	Protector (3 Phase)	KLIXON	20-7	Washer	AISI 304
14	Capacitor (1 Phase)	-	21-1	Spring Washer	AISI 304
19	Screw	AISI 304	21-4	Washer with O-ring	AISI 304+NBR
19-1	Screw	AISI 304	21-6	Spring Washer	AISI 304
19-2	Long Screw of motor	Steel	21-9	Spring Washer	AISI 304
19-3	Screw	AISI 304	22	Oil Filler Plug	AISI 304
19-4	Screw	AISI 304	22-1	O-ring of Oil Filler Plug	NBR
19-6	Screw	AISI 304	24	Wire and Screw	AISI 304
19-7	Screw	AISI 304	31	Nut of impeller	AISI 304
19-8	Screw	AISI 304	31-1	Nut of Elbow	AISI 304
19-9	Screw	AISI 304	35	Key	AISI 304

Construction



BN SERIES 4~5.5HP

NO	Part	Material	Photo	NO	Part	Material	Photo
2	Handle	ASTM A36		12	Pump Casing (BN65)	EN-GJL-200	
3	Motor Cover	EN-GJL-200		12	Pump Casing (BN80)	EN-GJL-200	
4	Bracket	EN-GJL-200		15-1 15-2	Upper Bearing Lower Bearing	NTN/TPI	
5	Motor Housing +Stator	AISI 304		17-1 17-2	O-rings	NBR	
6	Shaft with Rotor	AISI 410		18	Gasket	NBR	
7	Oil Chamber	EN-GJL-200		18-1	Elbow Gasket (BN65)	NBR	
8	Mechanical Seal	CA/CE + SIC/SIC		18-1	Elbow Gasket (BN80)	NBR	
9	Seal Housing	EN-GJL-200		18-2	Flange Packing	NBR	
10	Lip Seal	NBR		27	Flange (BN65)	EN-GJL-200	
11	Impeller	EN-GJL-200		28	Elbow	EN-GJL-200	

NO	Part	Material	NO	Part	Material
1	Cable	H07RN-F/ SJTOW/STOW	20-7	Washer	AISI 304
13	Protector (3 Phase)	KLIXON	21-1	Spring Washer	AISI 304
19	Screw	AISI 304	21-4	Washer with O-ring	AISI 304+NBR
19-1	Screw	AISI 304	21-6	Spring Washer	AISI 304
19-2	Long Screw of motor	Steel	21-9	Spring Washer	AISI 304
19-3	Screw	AISI 304	22	Oil Filler Plug	AISI 304
19-4	Screw	AISI 304	22-1	O-ring of Oil Filler Plug	NBR
19-6	Screw	AISI 304	24	Wire and Screw	AISI 304
19-7	Screw	AISI 304	31	Nut of impeller	AISI 304
19-8	Screw	AISI 304	31-1	Nut of Elbow	AISI 304
19-9	Screw	AISI 304	35	Key	AISI 304
20-5	Washer	AISI 304			

Disassembly and Assembly

1. Disassembly

When disassembling pump, have a piece of cardboard or wooden board ready to place the different parts on as you work. Do not pile parts on top of each other. They should be laid out neatly in rows. The “O” ring and gasket cannot be used again once they are removed. Have replacement parts ready. Disassemble in the following order, referring to the sectional view.

Be sure to turn off power source before starting disassembly.

- (a) Remove pump casing bolts, raise the motor section, and remove pump casing.
- (b) Remove shaft head bolt and impeller.
- (c) Remove oil filler plug and drain lubricating oil.
- (d) Remove intermediate casing bolts and intermediate oil chamber.
(Remember that any lubricating oil remaining in the mechanical seal chamber will flow out.)
- (e) Carefully remove mechanical seal, taking care not to scratch sliding surface or motor shaft.

2. Assembly

Re-assemble in reverse order of disassembly.

- (a) During re-assembly, rotate the impeller by hand and check for smooth rotation. If rotation is not smooth, perform steps-(3) through -(5) again.
- (b) Upon completion rotate the impeller by hand from the suction inlet and check that it rotates smoothly.

Please obtain “O” rings, shaft seals and other parts from your dealer. Refer to part lists attached.

Nameplate format

				
MODEL:		MADE IN TAIWAN		
P2:	kW	HP	QMAX:	GPM
V	HZ	PHASE	HMAX:	FT
FLA:	A	RPM:	RPM	
WEIGHT:	LBS			
S.NO:				

Troubleshooting

Trouble	Cause	Remedy
Does not start. Starts, but immediately stops.	(1) Power failure	(1)~(3) Check power supply.
	(2) Voltage varies more than 10% of nominal value	
	(3) Significant drop in voltage	
	(4) Motor phase malfunction	(4) Inspect electrical circuit
	(5) Electric circuit connection faulty	(5) Correct wiring
	(6) Faulty connection of control circuit	(6) Inspect connections and magnetic coil
	(7) Fuses are blown	(7) Check circuit then replace fuse
	(8) Faulty magnetic switch	(8) Replace with correct switch
	(9) Water is not at level indicated by Float	(9) Raise water level
	(10) Float is not at appropriate level	(10) Adjust the position of float
	(11) Float is not effective	(11) Repair or replace
	(12) Short circuit breaker is activated	(12) Repair location of short circuit
	(13) Foreign matter clogging pump	(13) Remove foreign matter
	(14) Motor burned out	(14) Repair or replace
	(15) Motor bearing broken	(15) Repair or replace
Operates, but stops after a while.	(1) Prolonged dry operation has activated motor protector and caused pump to stop	(1) Raise water level to C.W.L
	(2) High liquid temperature has activated motor protector and caused pump to stop	(2) Lower liquid temperature
	(3) Reverse rotation	(3) Correct rotation
Does not pump. Inadequate volume.	(1) Reverse rotation	(1) Correct rotation (see Operation)
	(2) Significant drop in voltage	(2) Check power supply
	(3) Operating a 60Hz pump with 50Hz	(3) Check nameplate
	(4) Discharge head is high	(4) Recalculate and adjust operating point
	(5) Low operating water level causes air suction	(5) Raise water level or lower pump
	(6) Leaking from discharge piping	(6) Inspect, repair
	(7) Clogging of discharge piping	(7) Remove foreign matter
	(8) Foreign matter in suction inlet	(8) Remove foreign matter
	(9) Foreign matter clogging pump	(9) Remove foreign matter
	(10) Worn impeller	(10) Replace impeller
Over load	(1) Unbalanced current and voltage	(1) Check power supply
	(2) Significant voltage drop	(2) Check power supply
	(3) Motor phase malfunction	(3) Inspect connections and magnetic switch
	(4) Operating 50Hz pump on 60Hz	(4) Check nameplate
	(5) Reverse rotation	(5) Correct rotation (see Operation)
	(6) Low head. Excessive volume of water	(6) Replace pump with high head pump
	(7) Foreign matter clogging pump	(7) Remove foreign matter
	(8) Motor bearing is worn out or damaged	(8) Replace bearing
Pump vibrates; excessive operating noise.	(1) Reverse rotation	(1) Correct rotation
	(2) Pump clogged with foreign matter	(2) Disassemble and remove foreign matter



BOESCH PUMPS LLC

(305) 999-1769

BoeschPumps.com

sales@boeschpumps.com